

Instructions for wear checks of play equipment

The equipment must be checked for correct operation and safety, especially the points listed below:

Proof of maintenance

Playground.....

Structural stability

Date of installation

In order to check steel feet for corrosion, uncover the foundations once a year.

Checks depend on the type of equipment. Any equipment with moving parts must be checked at least twice a year, static equipment at least once a year.

Single equipment

Please pay attention to the **separate maintenance notes** of the following single equipment:

Intervals for maintenance work and checks generally depend on

- location
- usage
- frequency of use
- possible vandalism

	Order No.	
Platform, h = 1.50 m	L3.26300 / K3.26300	<input type="checkbox"/>
Ladder attachment to long side	3.67370	<input type="checkbox"/>
Ladder attachment to short side	3.67360	<input type="checkbox"/>
Curved sand chute	5.97090	<input type="checkbox"/>
Bottom sand chute	5.97060	<input type="checkbox"/>
Sand Tray	5.97070	<input type="checkbox"/>
Sand Wheel	5.97130	<input type="checkbox"/>
Sand Hoist with Shovel	5.97000	<input type="checkbox"/>

For more details see also our general instructions for maintenance of playgrounds!

Building Site
Order No. L5.01010

Version with square timber
Order No. K5.01000

Note: Please check that all documents are included!

Special notes, e.g. for repairs

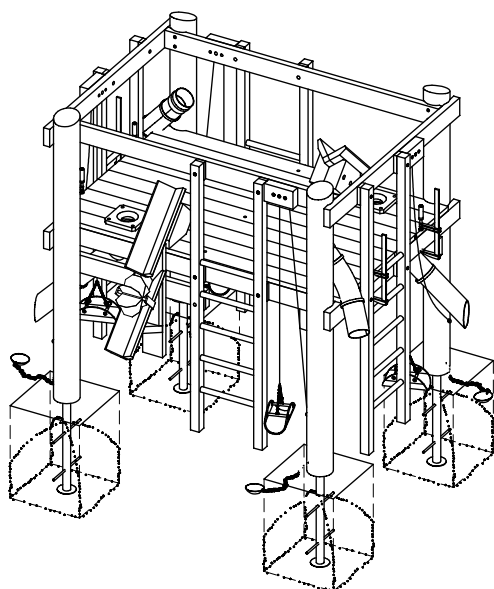

Repair not carried out, it is still possible to play on equipment

Repair not carried out, equipment is taken out of action

All work carried out, everything is in order

Maintenance carried out by:

..... Date











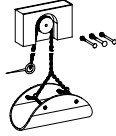

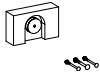

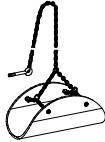

En-EN 14.06.2023

COPYRIGHT © RICHTER SPIELGERÄTE GMBH

Spare parts
Building Site
Order No. L5.01010/K5.01000

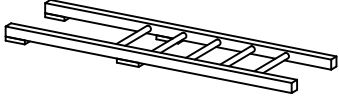
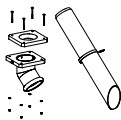
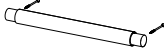

Please note that the safety standards of the equipment must not be affected. Therefore, when carrying out repairs it is helpful to **only use original parts**.

Order No.	Spare parts	Order No.	Spare parts
0.97000	Sand Hoist, complete 	0.97090	Bent Sand Pipe 
0.97010	Turn round roll with protection block 	0.97070	Sand Chute 
0.97020	Replacement Chain, complete 	99.00420	Block for Sand Chute 
0.97030	Tyre Segment 	99.00320	Upper Part for Sand Chute 
0.97032	Tyre Segment complete with Chain 	99.00330	Lower Part for Sand Chute 
0.97140	Tyre Segment without Chains 	0.97130	Sand Wheel 
0.97050	Shovel with Chain 	0.97082	Ladder, 5 rungs 
0.97060	Lower Sand Pipe 	0.98300	Single rung 
0.97100	Mounting Plate, top, incl. bolts 	0.30100	Timber for Handrail for Short Side 
0.97110	Mounting Plate, bottom incl. bolts 	0.30110	Timber for Handrail for Long Side 
		0.97105	Plate f. Refurnishment of Stand Posts 