



**Play value**

The child-friendly design of our little flyer immediately encourages children to play. Little ones can use the flyer for their first flight attempts, and the simple shapes make it easy to hold on to, climb on and steer. Older children will also love this flying machine, as they can stand on it, rocking and engage in role-playing games. Who wouldn't want to be a pilot?

**Fundamental characteristics**

- Friendly appearance
- Child-oriented dimensions
- Emotionally appealing design
- Natural wooden surface that appeals to the senses
- Incentive for playing: role-playing games
- Movement: climbing up, groping one's way along, rocking

**Recommended for**



- Children under 3 years
- Kindergarten children
- School children
- Supervised play areas, such as kindergartens, schools, after-school programmes or similar
- Public play areas without supervision, such as playgrounds, parks or similar
- Private play areas without supervision, such as camp sites or similar

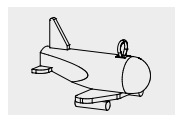

**Little Flyer**



**Order No. 4.23530**  
**Little Flyer**

Safety distance   
Device dimensions   
Functional distance 

80  
55

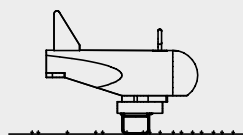

390  
90

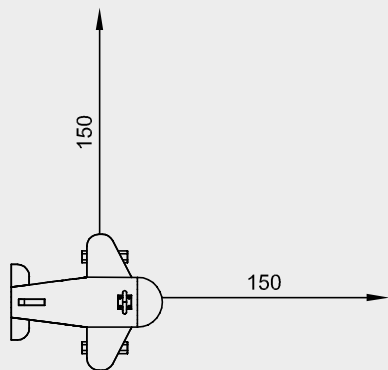

100  
400

Scale 1:50

Safety check according to DIN EN 1176

### Components

1 Little Flyer, mounted onto a galvanised rocking mechanism

Pre-fabricated foundation made of reinforced concrete C35/45 available, see **Order No. 4.24160** in the price list.

### Installation information

Surfacing requirements  
As for critical fall height  $\leq 1.00$  m  
(please refer to price list for more detailed information)

Foundations  
1 item 30 x 50 x 20 cm  
Excavation depth 40 cm

### Note

Loose fall protection material is not suitable for installation with pre-fabricated foundation.

### Attention:

**Exact measurements may vary;  
for all installation dimensions refer  
to current assembly instructions.**

Technical changes reserved.

### Technical information

Equipment made of non-impregnated mountain larch

### Peeled white

Palisades peeled white means that bark, cambium and sapwood are removed, the natural shape of the trunk is preserved and can be experienced



### Core-free

Sawn-timbers core-free, thus decreasing occurrences of cracking and undesired changes in shape



### Tongue and groove

Tongue and groove planks made of 4 cm solid wood, highly resilient, no trickling of dust / sand, protection against direct rain



### Ground anchor

All parts used for anchoring to the ground are made of hot-dip galvanised steel or stainless steel



### Relief cut

Targeted relief cut as an effective measure against cracks caused by drying. The cut defines the position of the stress equalization in the trunk and minimises natural cracking



**For more detailed explanation of the quality characteristics see price list.**

### Dimensions

(small deviations possible)

Total height	0.80 m
Height seat	0.55 m
Length	1.00 m
Width	0.90 m
Weight	55 kg

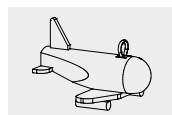

4.23530